

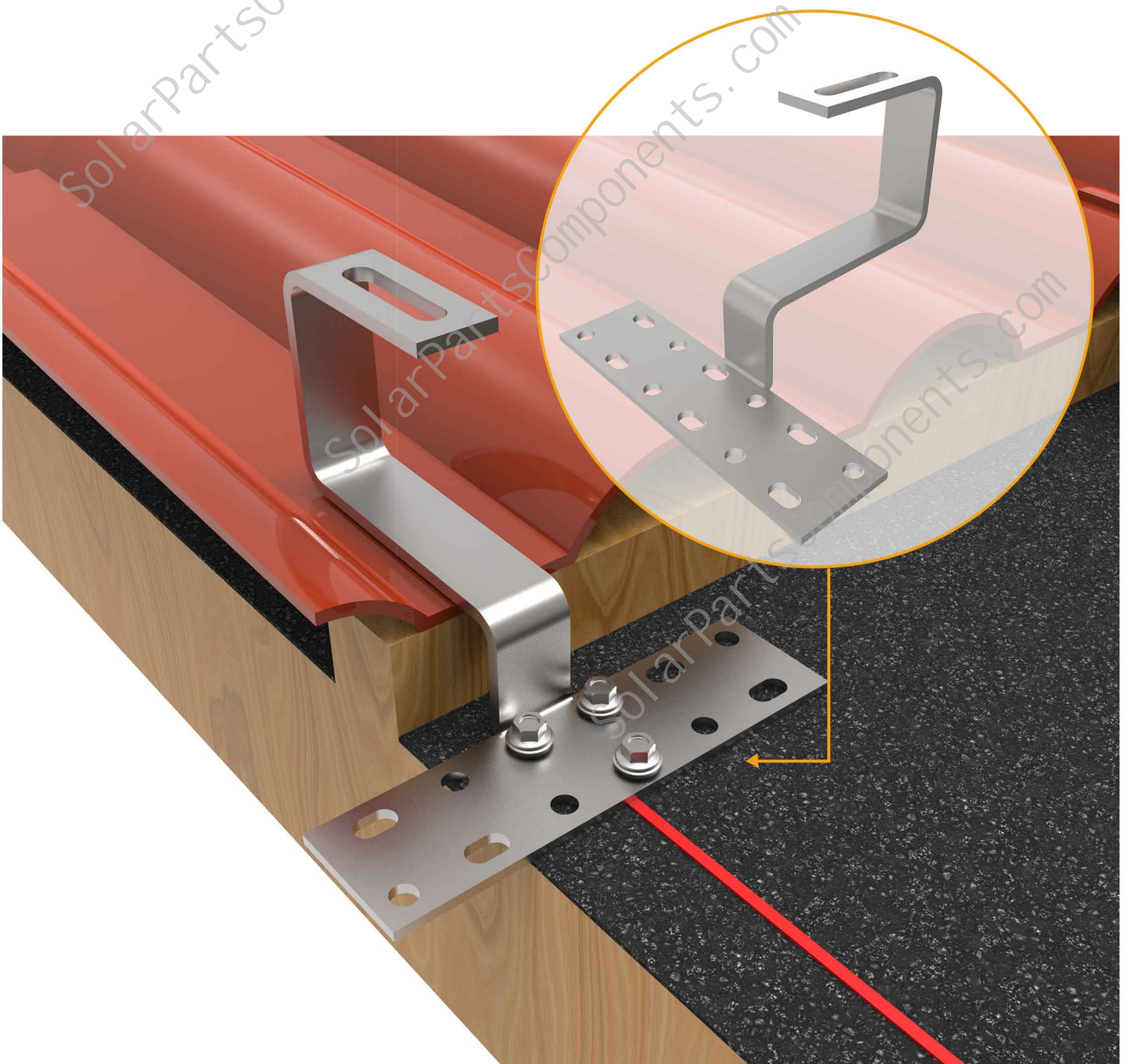

ROOF SOLUTION

INSTALLATION INSTRUCTIONS

FOR STAINLESS STEEL HOOK#07



Installation instructions for stainless steel hook#07

Step one, open the Spanish tiles



Step two, find the position of the main beam of the roof and mark it with a line above the main beam.



Step three, put the stainless-steel hook #07 on the installation position of the marking, and drill holes on the main beam with an electric drill according to the hole position on the hook, as picture 3 shows.

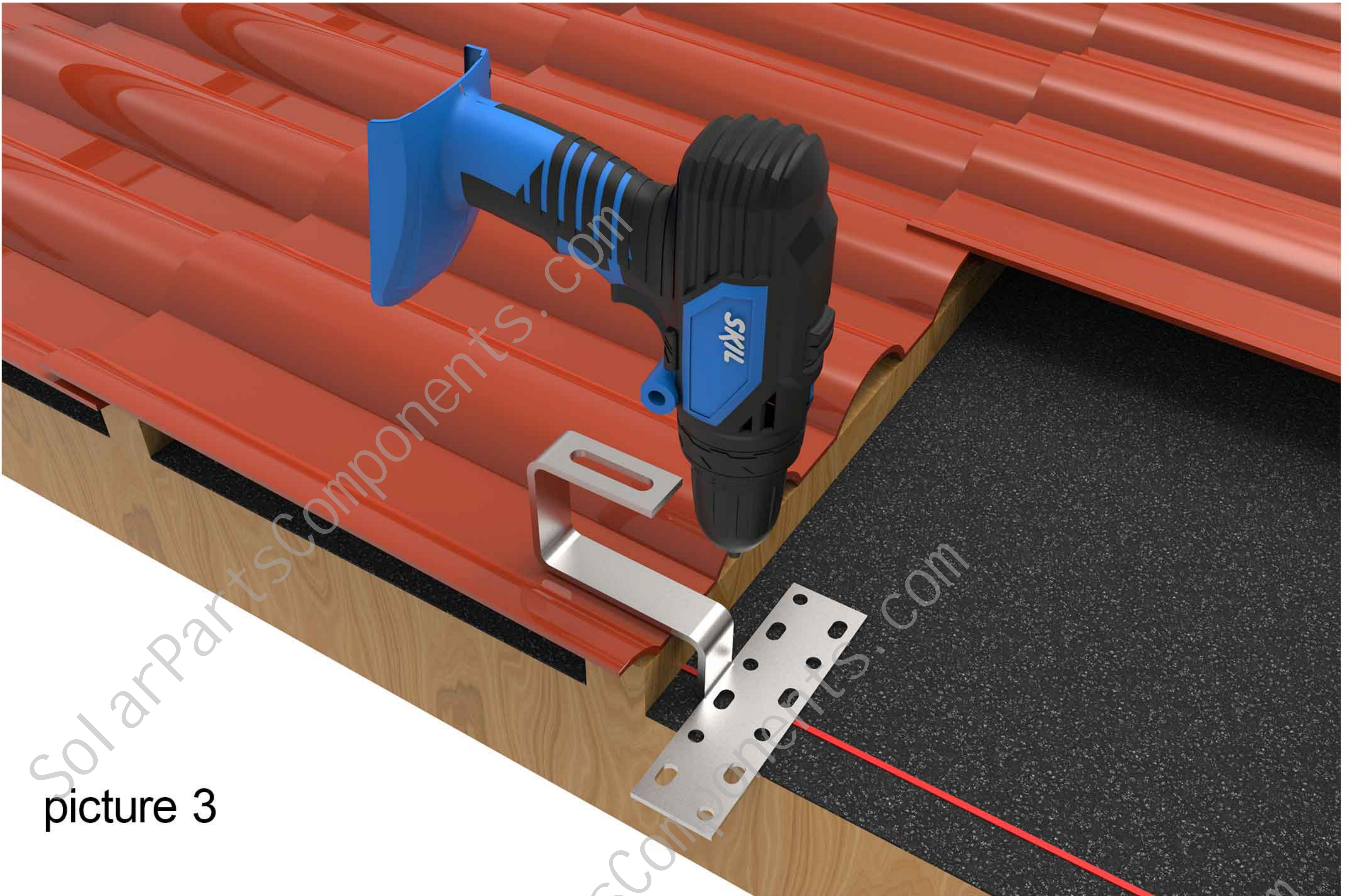

picture 3

The effect after drilling as picture 4 shows.

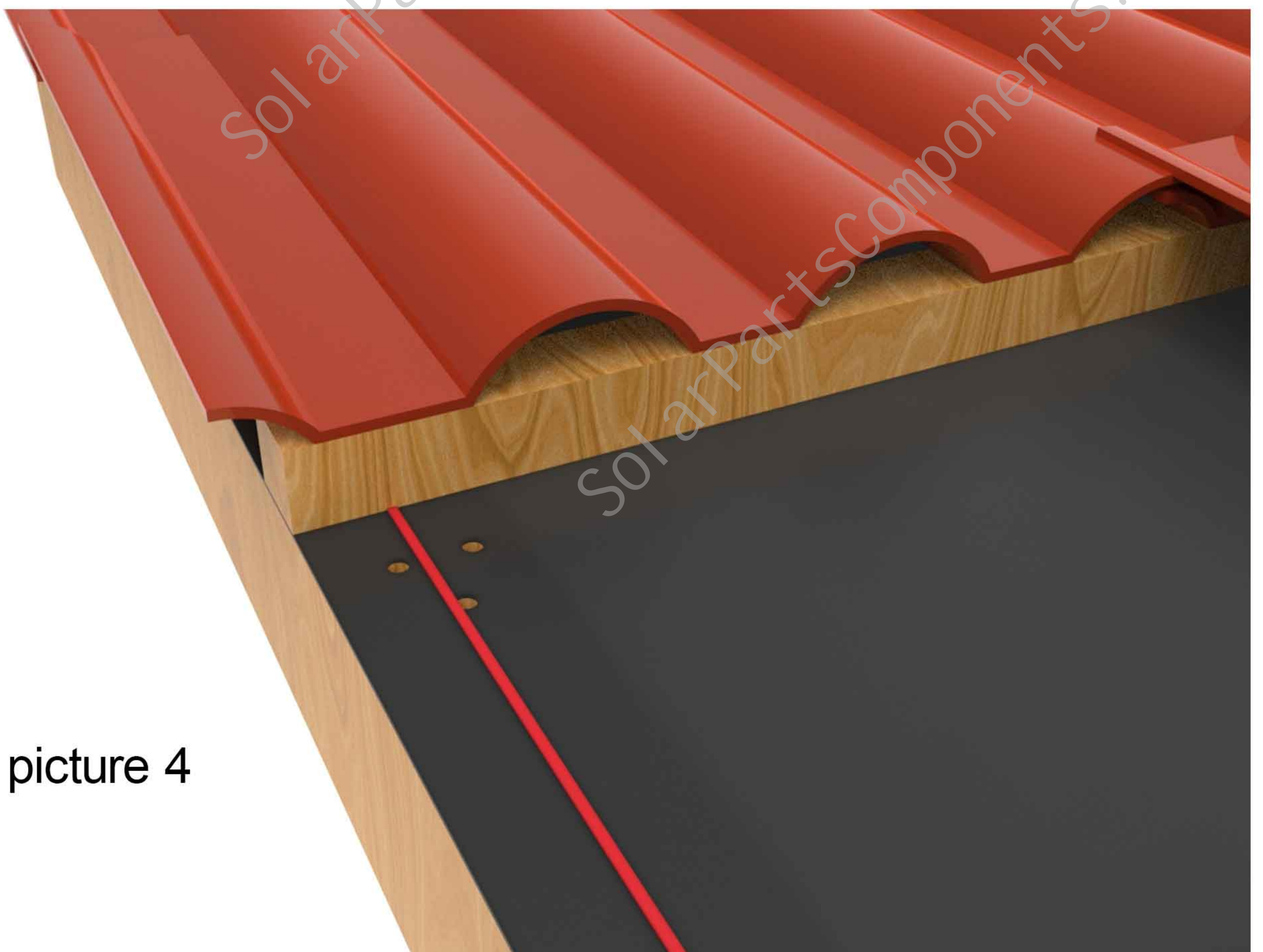

picture 4

Step four, apply sealant to the drilling position of the main beam, as picture 5 shows.



picture 5

Step five, put the stainless-steel hook #07 on the main beam, align the holes with the drilled holes, and fix the hook on the main beam with wood screws, as picture 6 shows.



picture 6

After fixing as picture 7 shows.

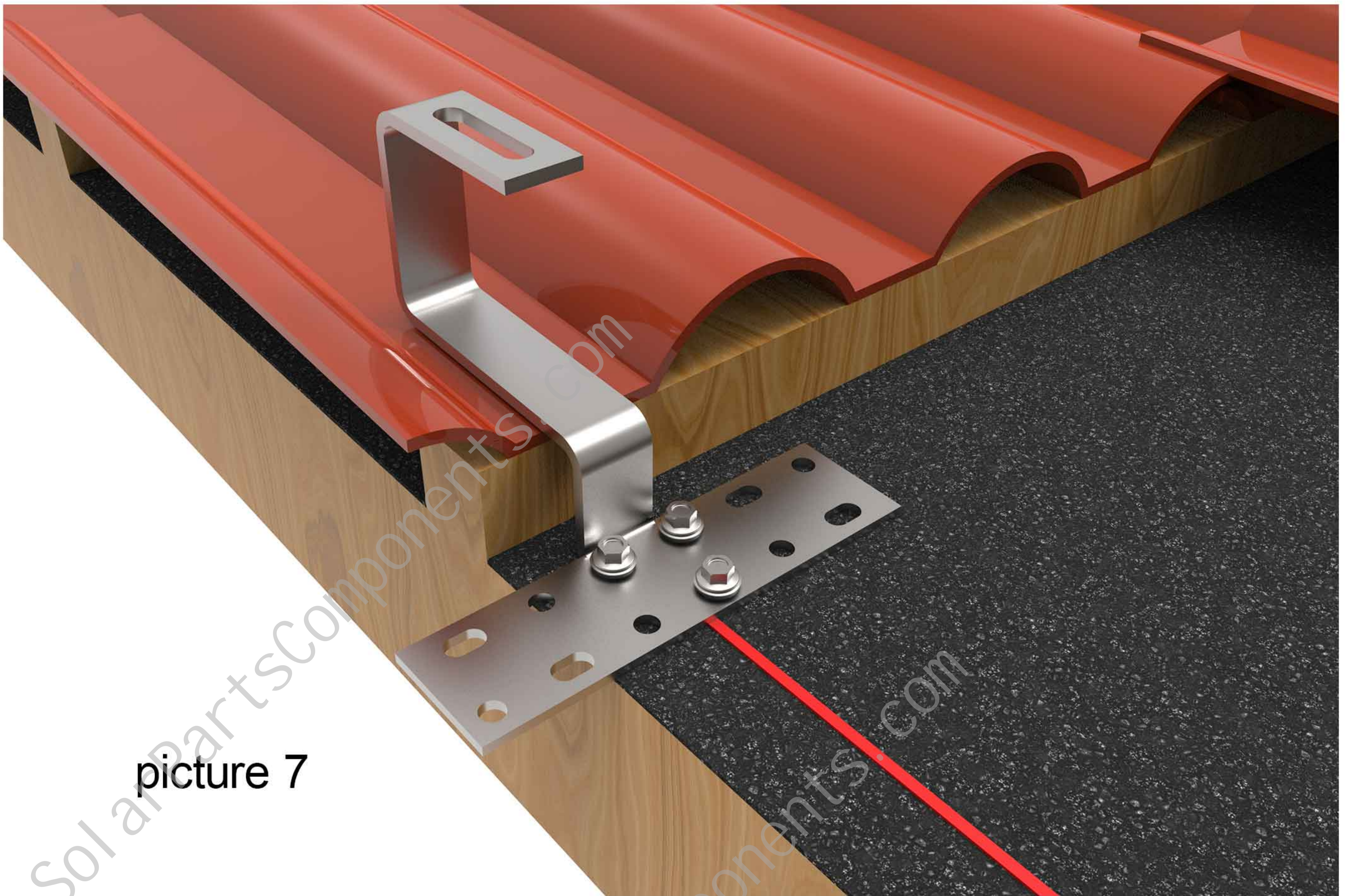

picture 7

Step six , the effect after installing the stainless-steel hook # 07 and covering the tiles as picture 8 shows. The upper part of the stainless-steel hook # 07 is exposed outside the tiles.



picture 8

Step seven, install the rail on the stainless-steel hook # 07 with M8*25 bolts. as picture 9 shows

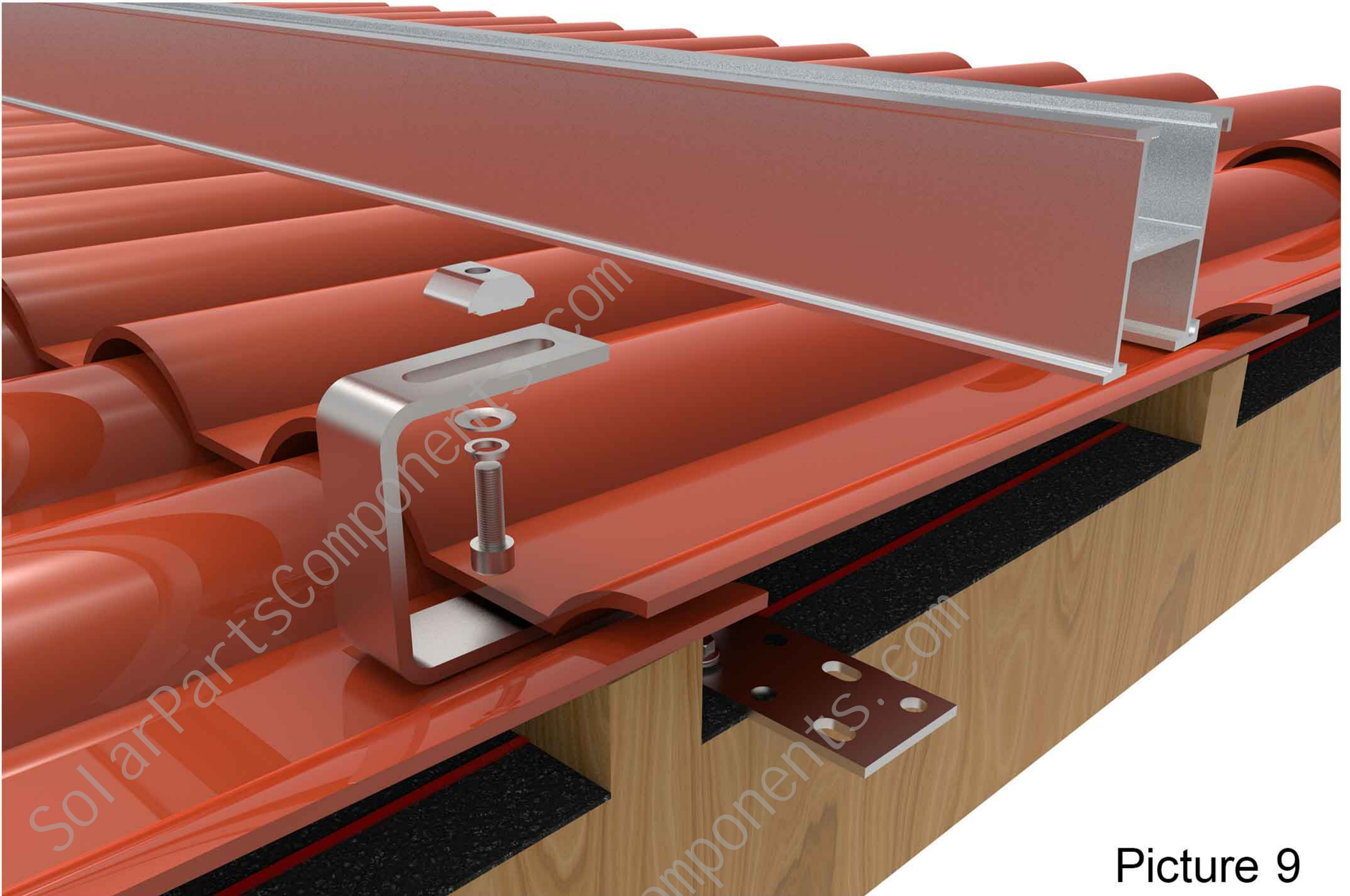

Picture 9

Step eight, effect after installation as picture 10 shows.

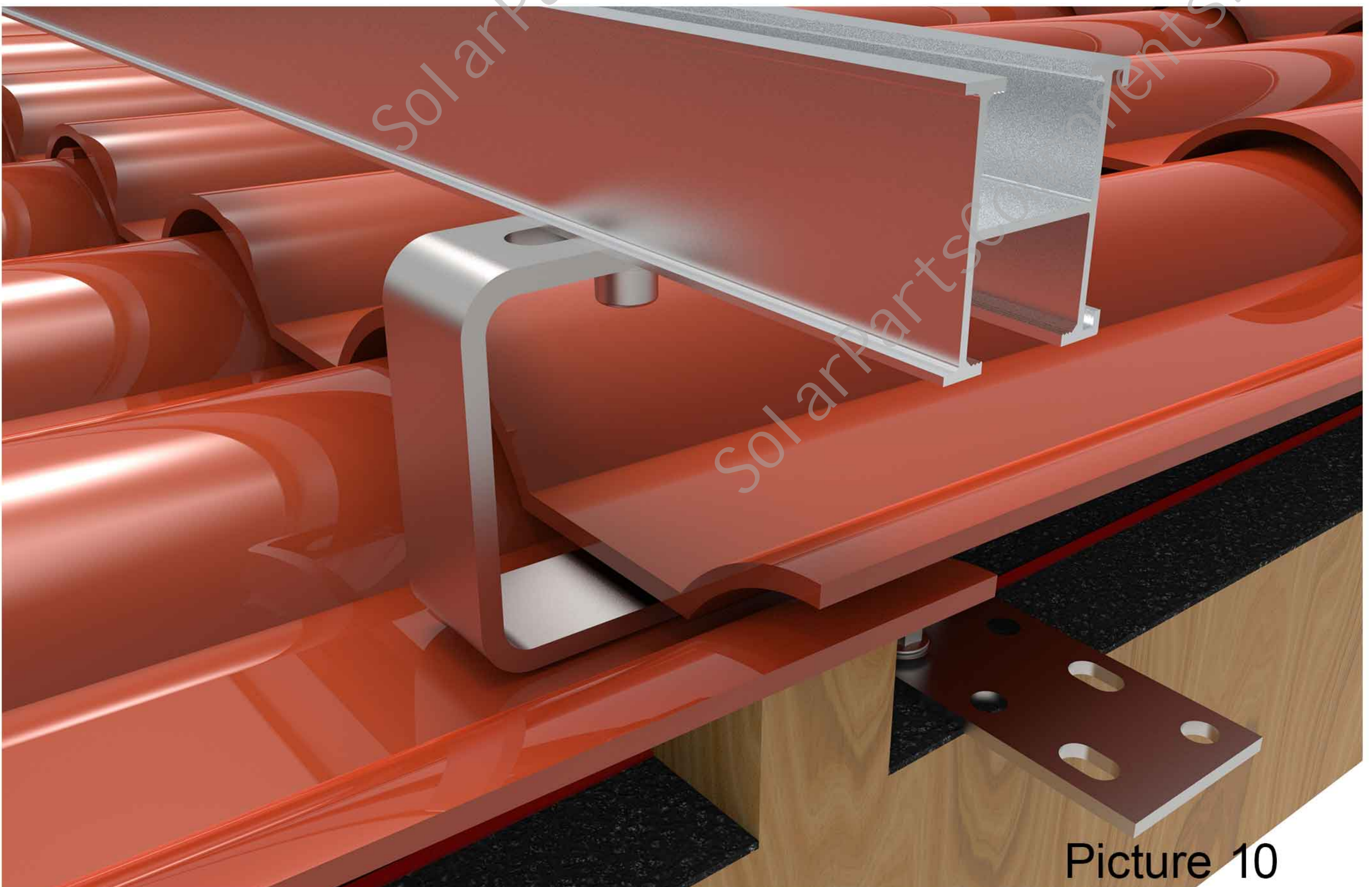

Picture 10

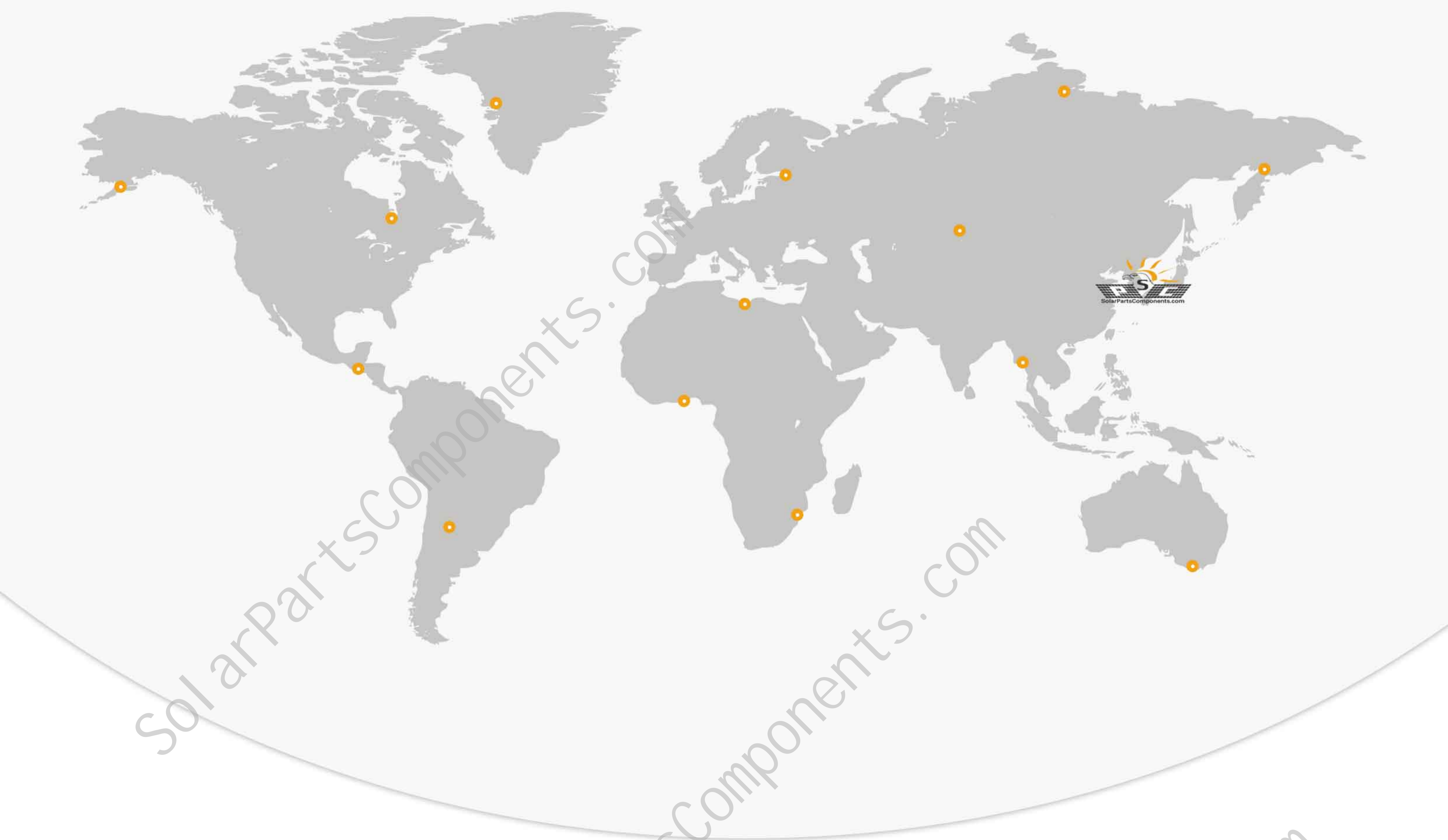

Solar Mounting Parts & Components Factory



SolarPartsComponents.com
XIAMEN TOP BEST TECH CO.,LTD
Info@SolarPartsComponents.com

